

PHF TB4040X70MM

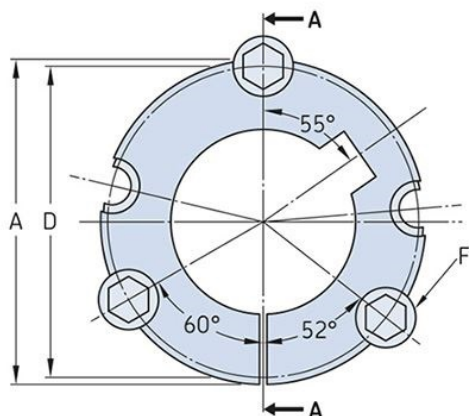

Bushing no.	TB4040
d = Bore diameter (mm)	70
Bore diameter (in)	2.76
Keyway width (mm)	20
Keyway width (in)	0.79
Keyway depth (mm)	4.9
Keyway depth (in)	0.19
A (mm)	146
A (in)	5.75
B (mm)	102
B (in)	4.02
D (mm)	141
D (in)	5.55
E (mm)	-
E (in)	-
F (mm)	15.875 x 44.45
F (in)	-
Weight (kg)	7.87
Weight (lbs)	17.35